

Cylindrical Photoelectric Sensor

CY-111, CY-19□, CY-12□ Series

Thank you for purchasing products from Panasonic. Please read this Instruction Manual carefully and thoroughly for the correct and optimum use of this product. Kindly keep this manual in a convenient place for quick reference.

⚠ WARNING

- Never use this product as a sensing device for personnel protection.
- In case of using sensing devices for personnel protection, use products which meet laws and standards, such as OSHA, ANSI or IEC etc., for personnel protection applicable in each region or country.

1 Cautions

- This product has been developed / produced for industrial use only.
- This product is suitable for indoor use only. The cable extension up to a total of 10m or less with a strength of 0.34mm² or less (each emitter and receiver of the thru-beam type) is possible.
- Make a cable length as short as possible to lessen noise pickup.
- Make sure that the power supply is off while wiring.
- Verify that the supply voltage including the ripple is within the rating.
- If power is supplied from a commercial switching regulator, ensure that the frame ground (F.G.) terminal of the power supply is connected to an actual ground.
- Shortcircuiting the load or wrong wiring may burn or damage the product.
- Ensure that an isolation transformer is utilized for the DC power supply. If an autotransformer is utilized, the main body or power supply may be damaged.
- If the used power supply generates a surge, connect a surge absorber to the power supply to absorb the surge.
- Do not use the sensor during the initial transient time (0.5 sec) after the power supply is switched on.
- Do not run the wires together with high-voltage lines or power lines or put them in the same raceway. This can cause malfunction due to induction.
- Avoid using the product where there are strong magnetic fields as they may prevent the product from working according to the specification.
- Take care that the sensor is not directly exposed to a fluorescent lamp from a rapid-starter lamp or a high frequency lighting device, as it may affect the sensing performance.
- Protect the sensor from water, oil, grease, organic solvents such as thinner, etc., strong acid, and alkaline.
- Avoid using a product where there is excessive vapor, dust or corrosive gases, or in a place where it could be exposed directly to water or chemicals.
- This product cannot be used in an environment containing inflammable or explosive gases.
- Never disassemble or modify the product.

2 Compliance with standards and directives

This product complies with the following standards and regulations.

- For the EU: EMC Directive 2004/108/EC
- For the US and Canada: ANSI/UL60947-5-2, CAN/CSA C22.2 No.14
- For Korea: S1-G-1-2009, S2-W-5-2009



In case you require a UL listing mark or C-UL listing mark, use a class 2 power supply unit.

RoHS directive

- This equipment complies with RoHS (CE and Chinese directive).

3 Sensor types

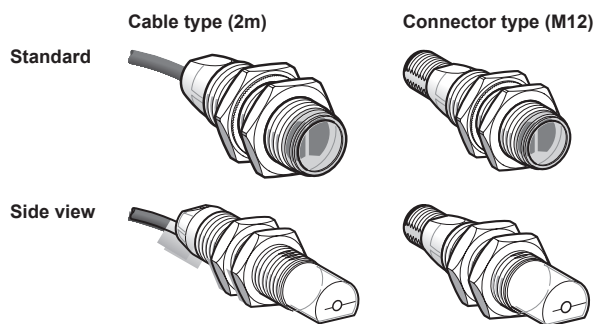

4 Part description

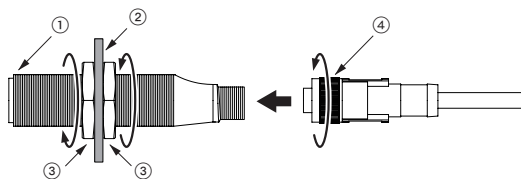

①	Main body
②	Mounting plate
③	Nut
④	Cable with connector

5 Mounting

General installation hints

1. Attach the sensor directly on your equipment or use one of the optional mounting brackets to fix the sensor.
2. The tightening torque should be 3Nm or less.
3. If you mount a M12 connector type, you can use the optional cable with the connector UZZ812□□D. The tightening torque for the connector part should be 3Nm or less.

Mounting with the mounting bracket MS-CY1-1

1. Using the holes indicated ①, screw the mounting bracket to the surface.
2. Feed the sensor into the mounting hole ② and affix it with the nuts on the sensor.

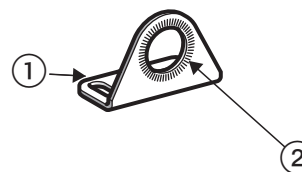

Mounting with the mounting bracket MS-CY1-2

1. Using the holes indicated ①, screw the mounting bracket to the surface.
2. Feed the sensor into the mounting hole ② and adjust its direction.
3. Use the upper two screws ③ to secure the sensor.

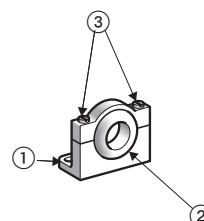

Model no.	Description
MS-CY1-1	Material: Stainless steel
MS-CY1-2	Material: Plastic (recommended for a more flexible beam axis alignment)

6 Mating cables

There are two types of mating cables: straight type and elbow type. You only need mating cables for the connector type (M12).

Straight type

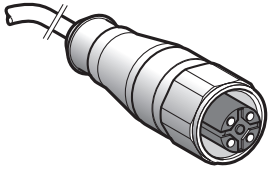

Elbow type

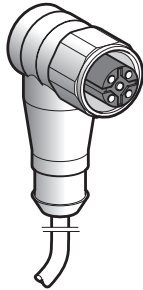

Cable type	Model no.	Description
Straight	UZZ81220D	Length: 2m
	UZZ81250D	Length: 5m
Elbow	UZZ81221D	Length: 2m
	UZZ81251D	Length: 5m

7 Reflectors

Square form

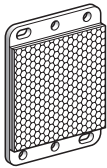

Hexagonal form

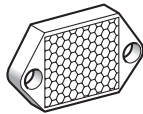

Reflective tape

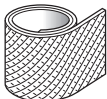

Reflector form	Model no.	Description
Square	RF-420	50 x 50mm
Hexagonal	RF-410	24 x 21mm
Reflective tape	RF-40RL5	22 x 5m, thickness: 0.4mm

8 Wiring diagrams

Emitter of thru-beam type

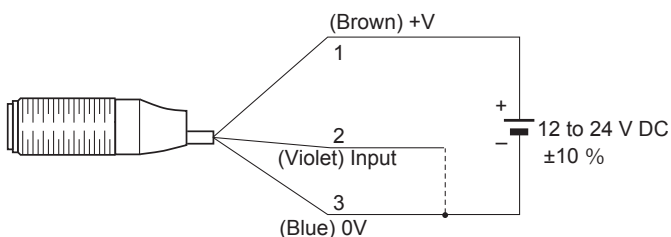

Receiver of thru-beam / reflective type (NPN)

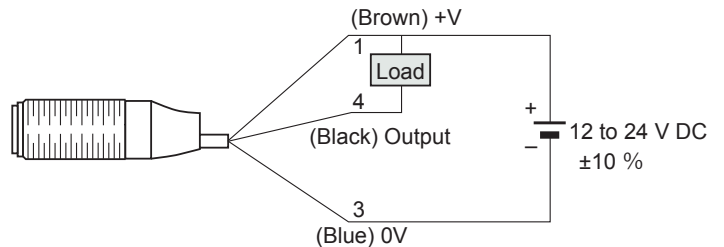

Receiver of thru-beam / reflective type (PNP)

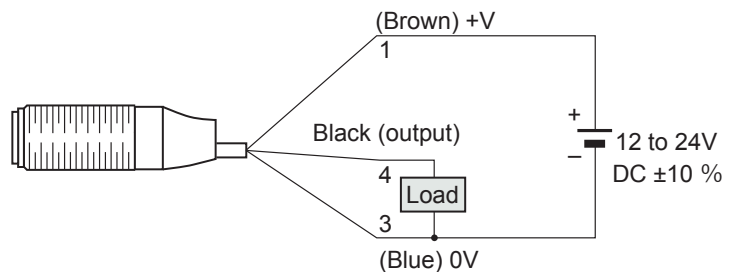

9 Terminal arrangement

M12 connector

Terminal no.	Function
①	+V
②	Input (only emitter of thru-beam type)
③	0V
④	Output (only receiver of thru-beam and reflective type)

Make sure to insulate the ends of all unused lead wires.

10 Detection curves

Thru-beam type

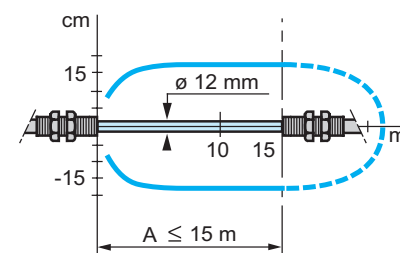

A = Sensing range

Diffuse reflective type

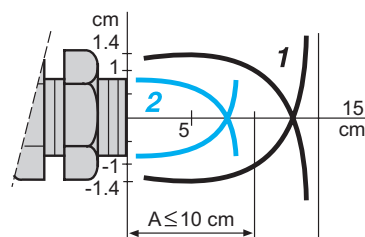

Object 10 x 10cm; 1= White 90%, 2 = Gray 18%

Diffuse reflective type with adjustable sensitivity

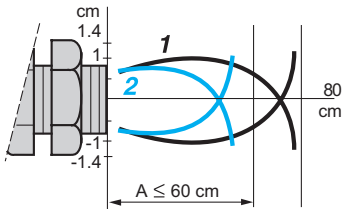

Object 10 x 10cm; 1= White 90%, 2 = Gray 18%

Retroreflective type

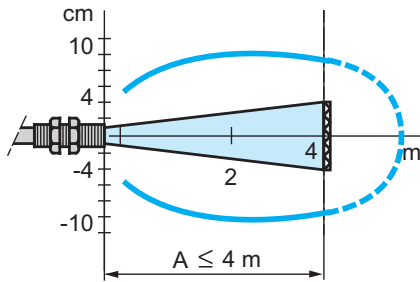

With reflector RF-420

Retroreflective type with polarizing filters

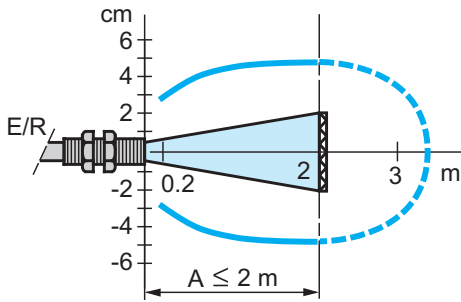

With reflector RF-420

11 Dimensions

CY-1□

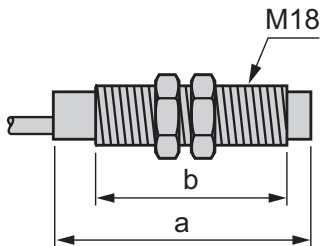

	Cable type		Connector type	
	a (mm)	b (mm)	a (mm)	b (mm)
Standard CY-111□/121□/192□	46	28	60	28
Standard CY-191□	48	28	62	28
Side view CY-111V□/121V□/ 191V□ /192V□	62	28	76	28
Standard CY-122□	62	44	76	44
Side view CY-122V□	78	44	92	44

Mounting bracket MS-CY1-1

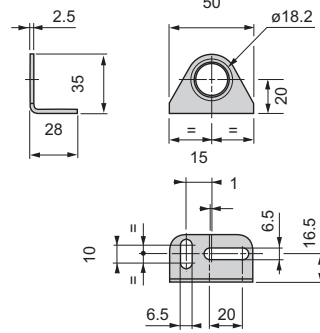

Mounting bracket MS-CY1-2

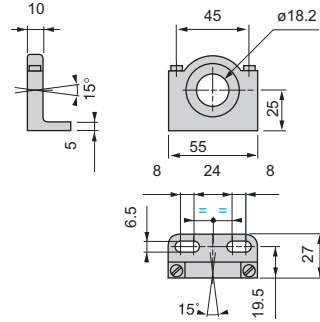

Reflector RF-420

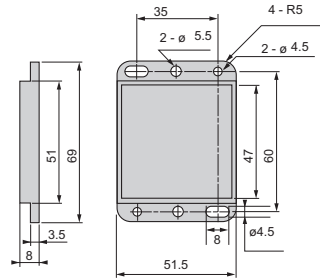

Reflector RF-410

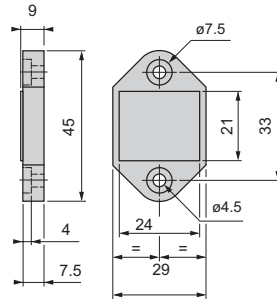

12 Specifications

The connector type (M12) is also available for all models in the following table. To order, simply add “-Z” at the end of the order information.

Type		Thru-beam (note 6)		Retroreflective				Diffuse reflective			
						With polarizing filters				With sensitivity adjuster	
		Standard	Side view	Standard	Side view	Standard	Side view	Standard	Side view	Standard	Side view
Model no.	Light-ON	CY-111A□	CY-111VA□	CY-192A□	CY-192VA□	CY-191A□	CY-191VA□	CY-121A□	CY-121A□	CY-122A□	CY-122VA□
	Dark-ON	CY-111B□	CY-111VB□	CY-192B□	CY-192VB□	CY-191B□	CY-191VB□	CY-121B□	CY-121VB□	CY-122B□	CY-122VB□
Sensing range		15m		4m (note 2)		2m (note 2)		100mm		600mm	
Sensing object		≤ ø18mm, opaque object (setting distance between emitter and receiver: 15m)		≤ ø50mm, opaque, translucent or transparent object (note 2, 4)		≤ ø50mm, opaque, translucent, transparent or specular object (note 2, 4)		Opaque, translucent or transparent object (note 4)			
Hysteresis		—						3 to 15% operating distance (note 3)			
Supply voltage		12 to 24V DC % (+10% / -10%), ripple ≤ P-P10%									
Current consumption		Emitter: ≤ 35mA Receiver: ≤ 35mA		≤ 35 mA							
Output		<p><u>NPN open-collector transistor</u></p> <ul style="list-style-type: none"> Maximum sink current: 100mA Applied voltage: ≤ 24 V DC or less between sensing output and 0V Residual voltage: ≤ 1.5V at maximum sink current <p><u>PNP open-collector transistor</u></p> <ul style="list-style-type: none"> Maximum source current: ≤ 100 mA Applied voltage: ≤ 24V DC (output and +V) Residual voltage: ≤ 1.5V at maximum source current 									
Short-circuit protection		Incorporated									
Response time		≤ 1ms									
Test input function		Incorporated		—							
Operation indicator		Yellow LED lights up when the output is ON; incorporated on the receiver for thru-beam type									
Power indicator		Green LED lights up		—							
Pollution degree		3 (Industrial environment)									
Protection		IP67 (IEC)									
Ambient temperature		-25 to +55°C (no dew condensation or icing allowed), Storage: -40 – +70°C									
Ambient humidity		50% RH (at +70°C)									
Ambient illuminance		Incandescent light: 5,000lx at the light receiving face									
EMC		EN 60947-5-2									
Voltage withstandability		500V AC									
Vibration resistance		10 to 55 Hz frequency, 0.5 mm amplitude in X, Y and Z directions for three times each									
Shock resistance		294 m/s ² acceleration in X, Y and Z directions for three times each									
Emitting element		Infrared LED				Red LED		Infrared LED			
Peak emission wavelength		890 nm		875 nm		665 nm		875 nm			
Material		Enclosure: PBT, Lens: PMMA									
Cable (except for connector type)		0.44 mm ² 3-core cab tire cable									
Cable extension		Extension up to total 10 m is possible with 0.34 mm ² cable									
Net weight (note 5)	Cable type	≈65g	≈70g	≈65g	≈70g	≈65g	≈70g	≈65g	≈70g	≈75g	
	Connector type	≈15g	≈20g.	≈15g	≈20g	≈15g	≈20g	≈15g	≈20g	≈25g	
Accessories		Nut: 4 pcs.				Nut: 2 pcs.					

- Where measurement conditions have not been specified precisely, the conditions used were an ambient temperature of +23°C.
- The sensing range and the sensing object of the retroreflective type sensor are specified for the RF-420 reflector (optional).
- The sensing range and the hysteresis of the diffuse reflective type sensor are specified for white non-glossy paper (200 x 200mm) as sample object.
- Make sure to confirm the detection for the transparent and translucent object with an actual sensor before use.
- The weight includes the weight of the nuts.
- The model No. with “E” shown on the label affixed to the thru-beam type sensor is the emitter, “D” shown on the label is the receiver, (e.g.) emitter of CY-111A: CY-111E, receiver of CY-111A: CY-111AD.